

GENERAL DESCRIPTION

The CM2838 family is a positive voltage linear regulator developed utilizing CMOS technology featured low quiescent current (25 μ A typ.), low dropout voltage, and high output voltage accuracy, making them ideal for battery applications. EN input connected to CMOS has low bias current. The space-saving SOT-23-5 package is attractive for "Pocket" and "Hand Held" applications.

These rugged devices have both Thermal Shutdown, and Current Fold-back to prevent device failure under the "Worst" of operating conditions.

In application requiring a low noise, regulated supply, place a 1000pF capacitor between Bypass and Ground.

The CM2838 is stable with an output capacitance of 2.2 μ F or greater.

FEATURES

- ◆ Good Noise Rejection : 62dB
- ◆ Very Low Dropout Voltage , 0.2V@70mA
- ◆ Low Current Consumption: Typ. 25 μ A, Max. 35 μ A
- ◆ Extra low shutdown current: 0.1uA
- ◆ Output Voltage: 1.8V, 2.5V , 2.8V, 3.0V, 3.3V
- ◆ High Accuracy Output Voltage: +/- 1.5%
- ◆ Fast enable start up (turn on time) : 20us
- ◆ Guaranteed 300mA Output
- ◆ Input Range up to 7.0V
- ◆ Thermal Shutdown
- ◆ Current Limiting
- ◆ Compact Package: SOT-23-5
- ◆ Factory Pre-set Output Voltages
- ◆ Short Circuit Current Fold-Back
- ◆ Low Temperature Coefficient

APPLICATIONS

- ◆ Battery-powered devices
- ◆ Personal communication devices
- ◆ Home electric/electronic appliances
- ◆ PC peripherals

TYPICAL APPLICATIONS

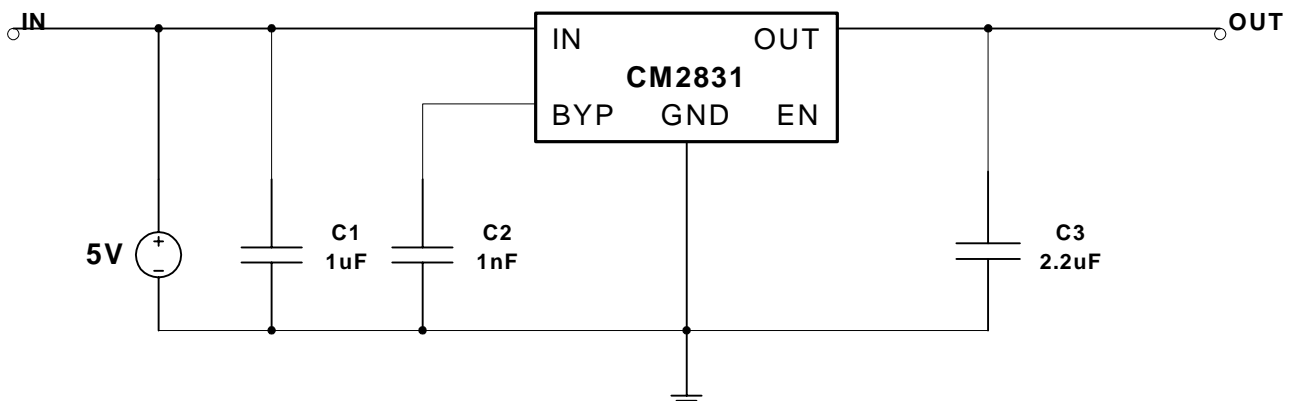

PIN CONFIGURATION

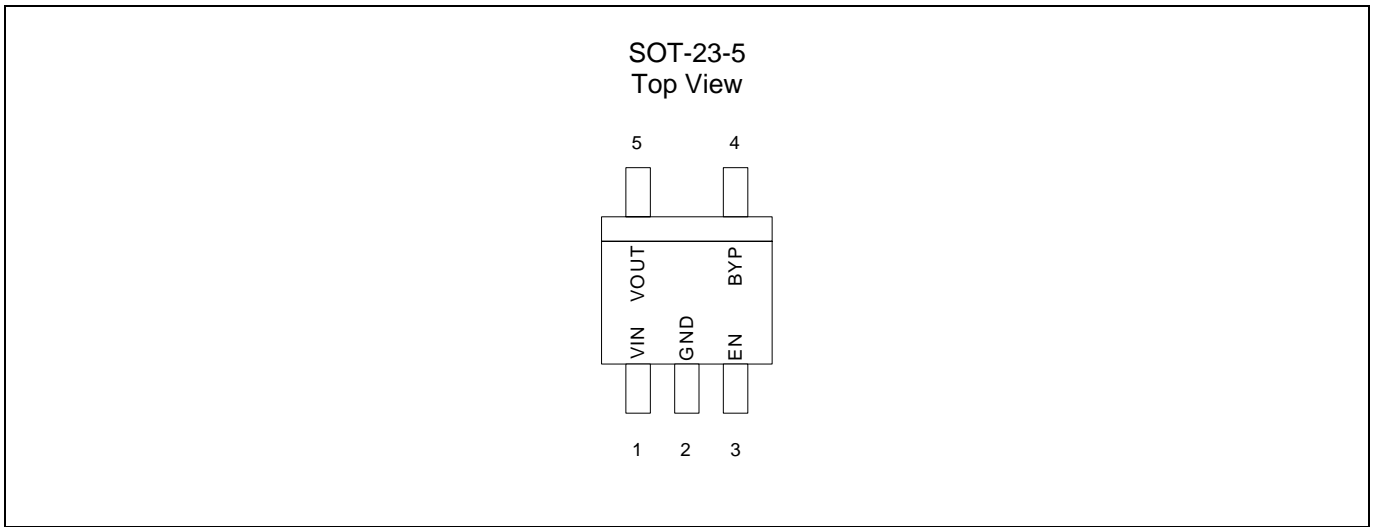

BLOCK DIAGRAM

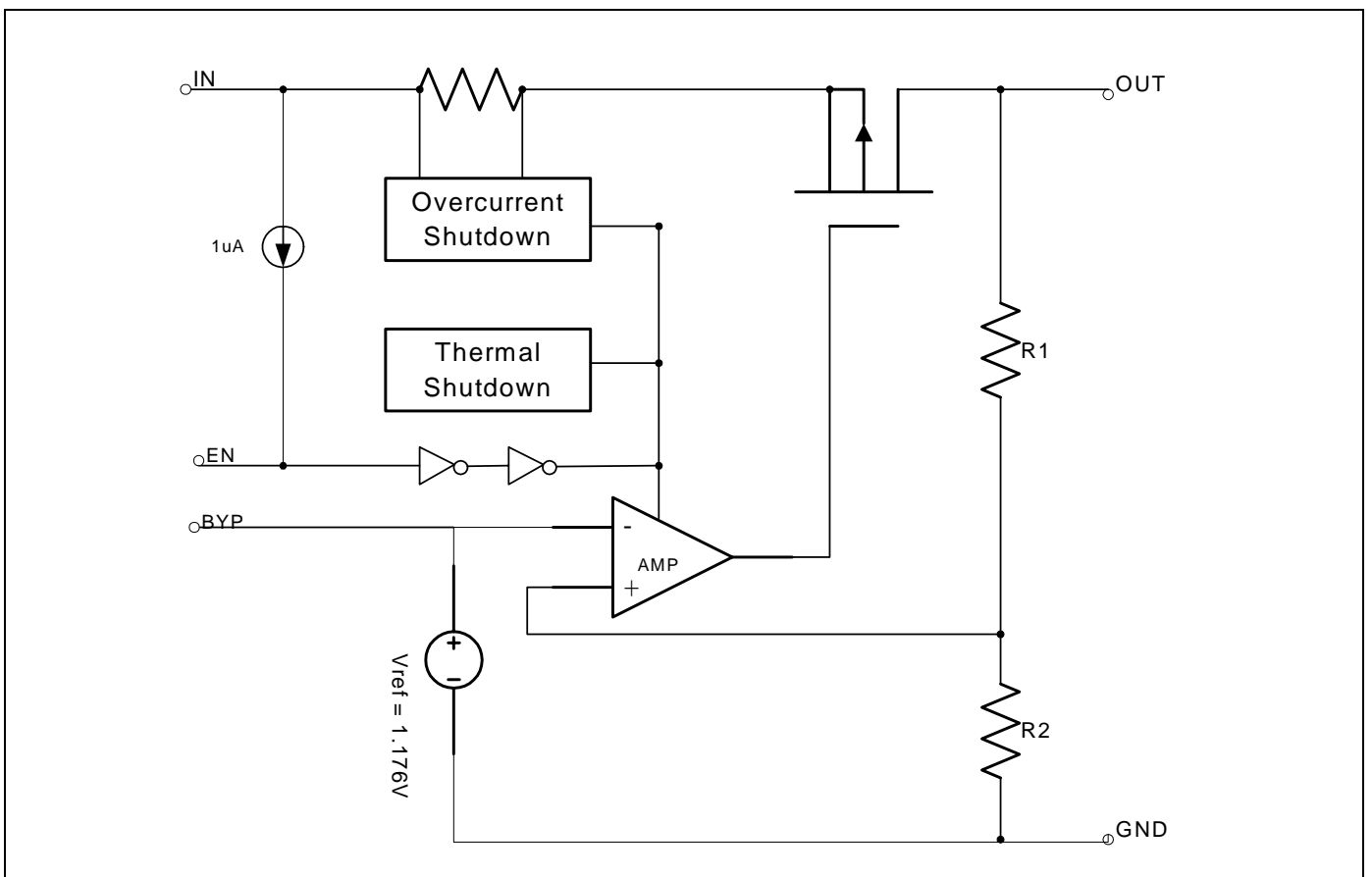

ORDERING INFORMATION

Part Number	Output Voltage	Temperature Range	Package
CM2838GDIM25	1.8V	-40°C ~ +85°C	SOT-23-5
CM2838GKIM25	2.5V	-40°C ~ +85°C	SOT-23-5
CM2838GNIM25	2.8V	-40°C ~ +85°C	SOT-23-5
CM2838GPIM25	3.0V	-40°C ~ +85°C	SOT-23-5
CM2838GSIM25	3.3V	-40°C ~ +85°C	SOT-23-5

Note: For other pre-set output voltage requirements, please contact Bookly Sales office.

ABSOLUTE MAXIMUM RATINGS

Input Voltage +7V
 Output Current $P_D / (V_{IN} - V_o)$ mA
 Output Voltage GND-0.3V to $V_{IN}+0.3V$
 ESD Classification B

OPERATING RATINGS

Ambient Temperature Range (T_A) -40°C to +85°C
 Junction Temperature Range -40°C to +125°C

THERMAL INFORMATION

Parameter		Maximum	Unit
Thermal Resistance (θ_{jc})	SOT-23-5	160	°C/W
Internal Power Dissipation (P_D) ($\Delta T = 100^\circ C$)	SOT-23-5	320	°C/W
Maximum Junction Temperature		150	°C
Maximum Lead Temperature (10 Sec)		300	°C

Caution: Stress above the listed absolute rating may cause permanent damage to the device.

CM2838

300mA LDO WITH ON/OFF

ELECTRICAL CHARACTERISTICS

$T_A = +25^\circ\text{C}$; unless otherwise noted

Parameter	Symbol	Test Conditions	CM2838			Unit
			Min.	Typ.	Max.	
Input Voltage	V_{IN}		Note 1		7	V
Output Voltage Accuracy	V_{OUT}	$I_O = 1\text{mA}$	-1.5		1.5	%
Dropout Voltage	$V_{DROPOUT}$	$I_O = 300\text{mA}$, $V_{OUT} = V_{O(NOM)} - 2\%$	$1.2\text{V} < V_{O(NOM)} \leq 2.0\text{V}$		400	mV
			$2.0\text{V} < V_{O(NOM)} \leq 2.5\text{V}$		300	
			$2.5\text{V} < V_{O(NOM)}$		300	mV
Output Current	I_O	$V_{OUT} > 1.2\text{V}$	150			mA
Current Limit	I_{LIM}	$V_{OUT} > 1.2\text{V}$			400	mA
Short Circuit Current	I_{SC}	$V_{OUT} < 0.95\text{V}$		150	300	mA
Quiescent Current	I_Q	$I_O = 0\text{mA}$		30	50	μA
Ground Pin Current	I_{GND}	$I_O = 1\text{mA}$ to 300mA		30	50	μA
Line Regulation	REG_{LINE}	$I_{OUT} = 5\text{mA}$, $V_{IN} = V_{OUT} + 1$ to $V_{OUT} + 2$		0.02	0.1	%
Load Regulation	REG_{LOAD}	$I_O = 1\text{mA}$ to 300mA		0.2	1	%
Over Temperature Shutdown	OTS			150		$^\circ\text{C}$
Over Temperature Hysteresis	OTH			30		$^\circ\text{C}$
V_{OUT} Temperature Coefficient	TC			40		ppm/ $^\circ\text{C}$
Power Supply Rejection	PSRR	$I_O = 100\text{mA}$ $C_O = 2.2\ \mu\text{F}$ ceramic	$f = 1\text{kHz}$		65	dB
			$f = 10\text{kHz}$		58	
			$f = 100\text{kHz}$		48	
Power Supply Rejection	PSRR	$I_O = 100\text{mA}$ $C_O = 2.2\ \mu\text{F}$ ceramic $C_{BYP} = 0.1\ \mu\text{F}$	$f = 1\text{kHz}$		75	dB
			$f = 10\text{kHz}$		62	
			$f = 100\text{kHz}$		40	
Output Voltage Noise	eN	$f = 10\text{Hz}$ to 100kHz $I_O = 10\text{mA}$, $C_{BYP} = 0\ \mu\text{F}$	$C_O = 2.2\ \mu\text{F}$		30	μVrms
			$C_O = 100\ \mu\text{F}$		20	
Output Voltage Noise	eN	$f = 10\text{Hz}$ to 100kHz $I_O = 10\text{mA}$, $C_{BYP} = 0.01\ \mu\text{F}$	$C_O = 2.2\ \mu\text{F}$		30	μVrms
			$C_O = 100\ \mu\text{F}$		20	
Shutdown Supply Current	I_{SD}	$V_{IN} = 5.0\text{V}$, $V_{OUT} = 0\text{V}$, $V_{EN} < V_{EL}$		0.1	1	μA
EN Input Bias Current	I_{EH}	$V_{EN} = V_{IN}$, $V_{IN} = 2.6\text{V}$ to 7V			0.1	μA
	I_{EL}	$V_{EN} = 0$, $V_{IN} = 2.6\text{V}$ to 7V		0.1	1	μA
EN Input Threshold	V_{EH}	$V_{IN} = 2.6\text{V}$ to 7V	(Note2)		V_{IN}	V
	V_{EL}	$V_{IN} = 2.6\text{V}$ to 7V	0		0.4	V

Note 1. $V_{IN(MIN)} = V_{OUT} + V_{DROPOUT}$

Note 2. Based on our design architecture, the enable input threshold will depend on the input voltage. To ensure the stability of your design application, please set the $V_{EH(MIN)} = V_{IN}/2 + 0.8\text{V}$.

DETAILED DESCRIPTION

The CM2838 family of CMOS regulators contain a PMOS pass transistor, voltage reference, error amplifier, over-current protection, thermal shutdown, and short circuit protection.

The P-channel pass transistor receives data from the error amplifier, over-current shutdown, short output protection, and thermal protection circuits. During normal operation, the error amplifier compares the output voltage to a precision reference. Over-current and Thermal shutdown circuits become active when the junction temperature exceeds 150°C, or the current exceeds 300mA. During thermal shutdown, the output voltage remains low. Normal operation is restored when the junction temperature drops below 120°C.

The CM2838 switches from voltage mode to current mode when the load exceeds the rated output current. This prevents over-stress. The CM2838 also incorporates current fold-back to reduce power dissipation when the output is short-circuited. This feature becomes active when the output drops below 1.05V, and reduces the current flow by 65%. Full current is restored when the voltage exceeds 0.95V.

ENABLE

The Enable pin normally floats high. When actively, pulled low, the PMOS pass transistor shut off, and all internal circuits are powered down. In this state, the quiescent current is less than 0.1 μA. This pin behaves much like an electronic switch.

EXTERNAL CAPACITOR

The CM2838 is stable with an output capacitor to ground of 2.2 μF or greater. It can keep stable even with higher or poor ESR capacitors. A second capacitor is recommended between the input and ground to stabilize VIN. The input capacitor should be larger than 0.1 μF to have a beneficial effect. All capacitors should be placed in close proximity to the pins. A “quiet” ground termination is desirable.

TYPICAL ELECTRICAL CHARACTERISTICS

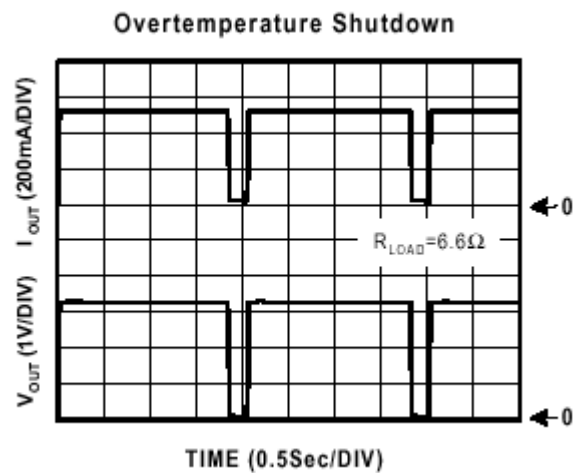
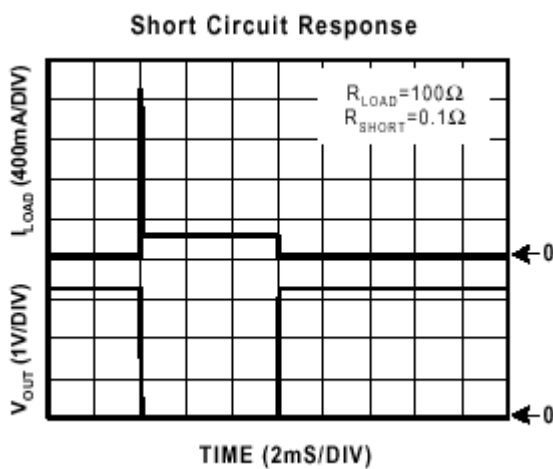
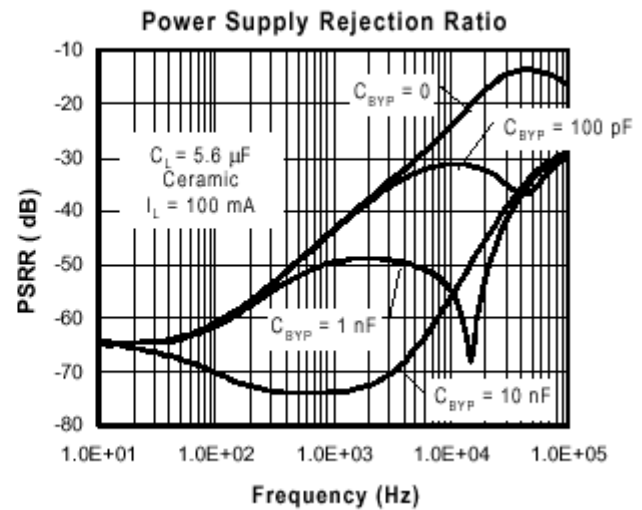
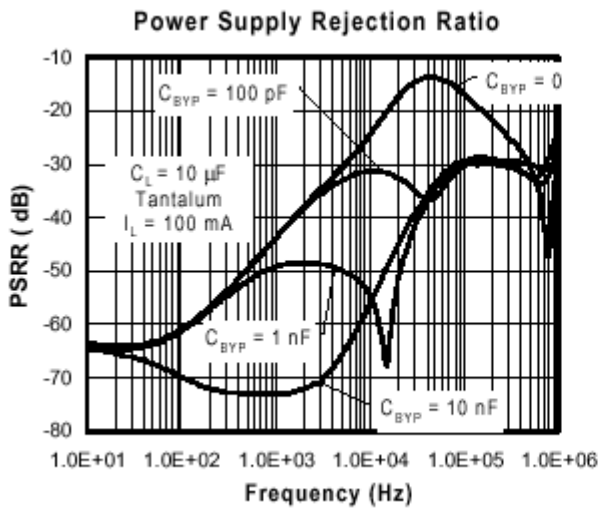
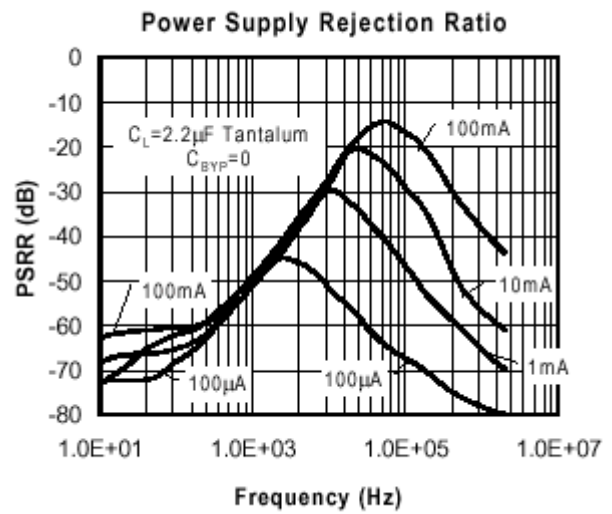
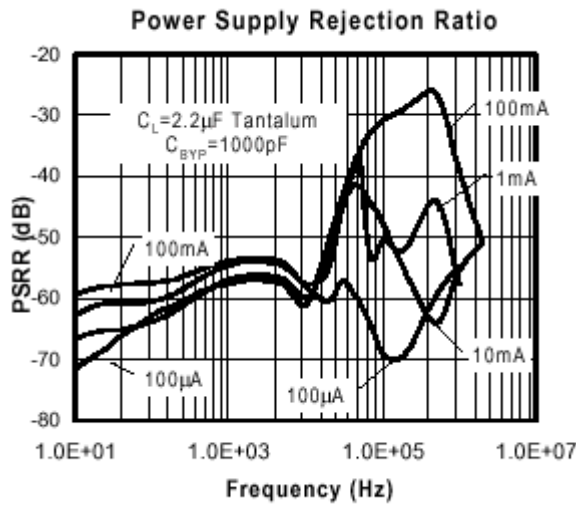

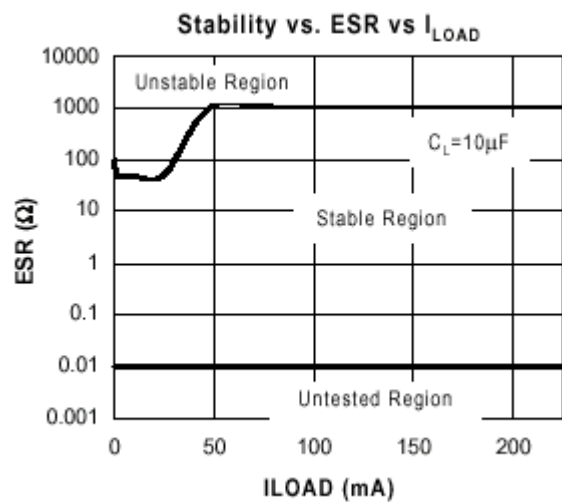
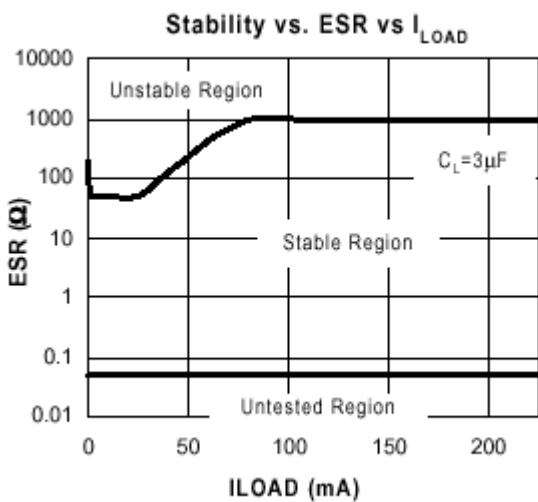
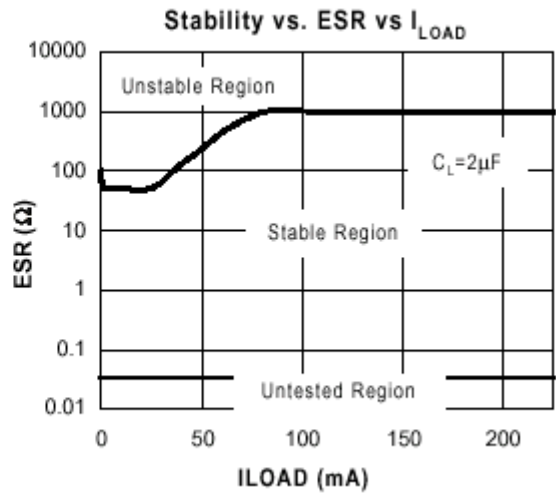
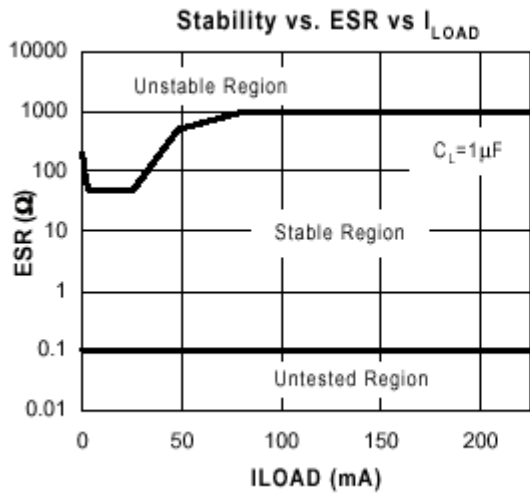
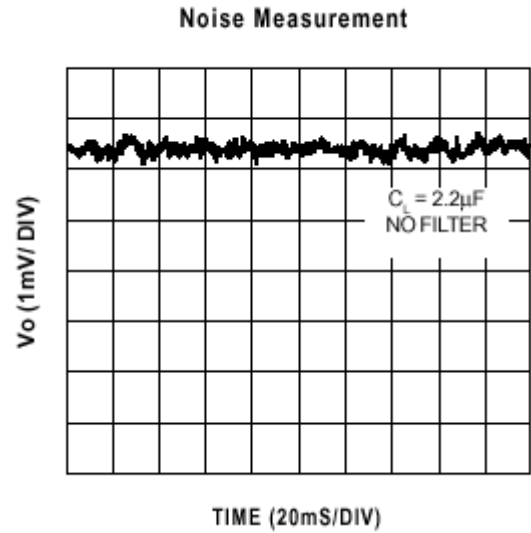
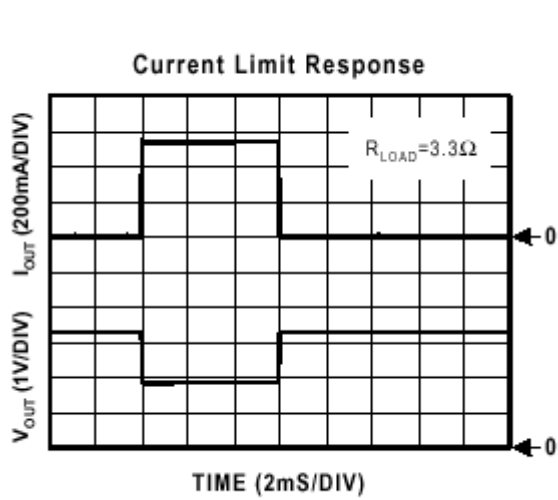

PACKAGE DIMENSION

SOT-23-5 (M25)

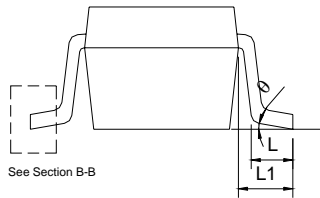
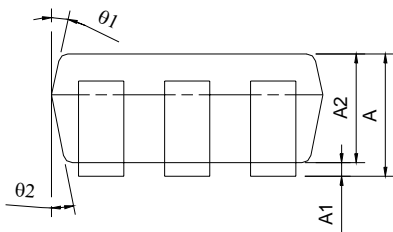
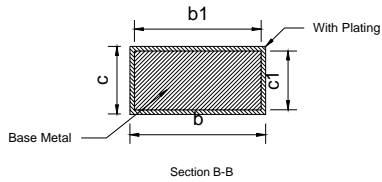
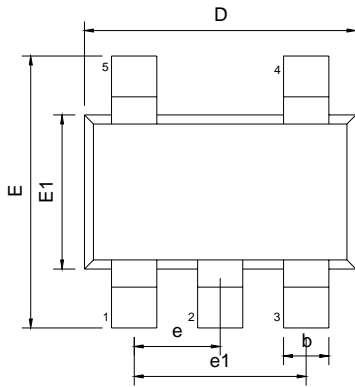

SYMBOLS	DIMENSIONS IN MILLIMETERS			DIMENSIONS IN INCHES		
	MIN	NOM	MAX	MIN	NOM	MAX
A	1.05	---	1.35	0.041	---	0.053
A1	0.05	---	0.15	0.002	---	0.006
A2	1.00	1.10	1.20	0.039	0.043	0.047
b	0.25	---	0.50	0.010	---	0.020
b1	0.25	0.40	0.45	0.010	0.016	0.018
c	0.08	---	0.20	0.003	---	0.008
c1	0.08	0.11	0.15	0.003	0.004	0.006
D	2.70	2.90	3.00	0.106	0.114	0.118
E	2.60	2.80	3.00	0.102	0.110	0.118
E1	1.50	1.60	1.70	0.059	0.063	0.067
L	0.35	0.45	0.55	0.014	0.018	0.022
L1	0.60 REF			0.024 REF		
e	0.95 BSC			0.037 BSC		
e1	1.90 BSC			0.075 BSC		
theta	0°	5°	10°	0°	5°	10°
theta1	3°	5°	7°	3°	5°	7°
theta2	6°	8°	10°	6°	8°	10°